



EHL PROLIST

Din listdistributör med oslagbar flexibilitet

Sortimentslista

2026-03-01

Avvikande dimensioner

Om våra standarddimensioner inte passar era behov kan vi tillverka produkter i specialanpassade mått.

Exaktkapningar

Behöver ni leverera material med exakta mått till era kunder? Vi erbjuder precisionskapning för att underlätta ert arbete.

Anpassade kulörer

Vi kan leverera listverk i anpassade kulörer för att möta era specifika behov och önskemål.

Unika profiler

Har ni behov av unika profiler? Vi tillverkar verktyg för att skapa profiler enligt era specifikationer.

Andra träslag

Förutom sortimentslistans standardutbud kan vi erbjuda fler träslag. Kontakta oss gärna för en offert!

Rengöring – använd ett mildt rengöringsmedel och en lätt fuktad trasa.

Övermålningsbar – rugga upp ytan som är vaxliknande. Detta gör att ny färg får lättare att fästa. Applicera därefter ny färg. Alternativt välj våra grundmålade lister.

Furu obh	obehandlad furu	typ A
Furu B	obehandlad furu	typ B
Furu vit	ncs S 0502-Y	glans 20-25
Furu vit	ncs S 0500-N	glans 20-25
MDF vit	ncs S 0502-Y	glans 20-25
Lackad ek	klarlack	glans 10
Lackad björk	klarlack	glans 15-20

Furu grundmålad – grundmålad vit för enklare övermålning efter lätt slipning



Eesti Höövelliist OÜ

Liistuvabrik OÜ

EHL Prolist AB

Prolist Nordic AB

Grimslöv Trä och List AB

Rindalslist AS

Genom olika certifieringar arbetar vi helhetsorienterat, systematiskt och långsiktigt med åtgärder som kommer att förbättra vår roll som en hållbar leverantör.



Märket för ansvarfull skogsbruk



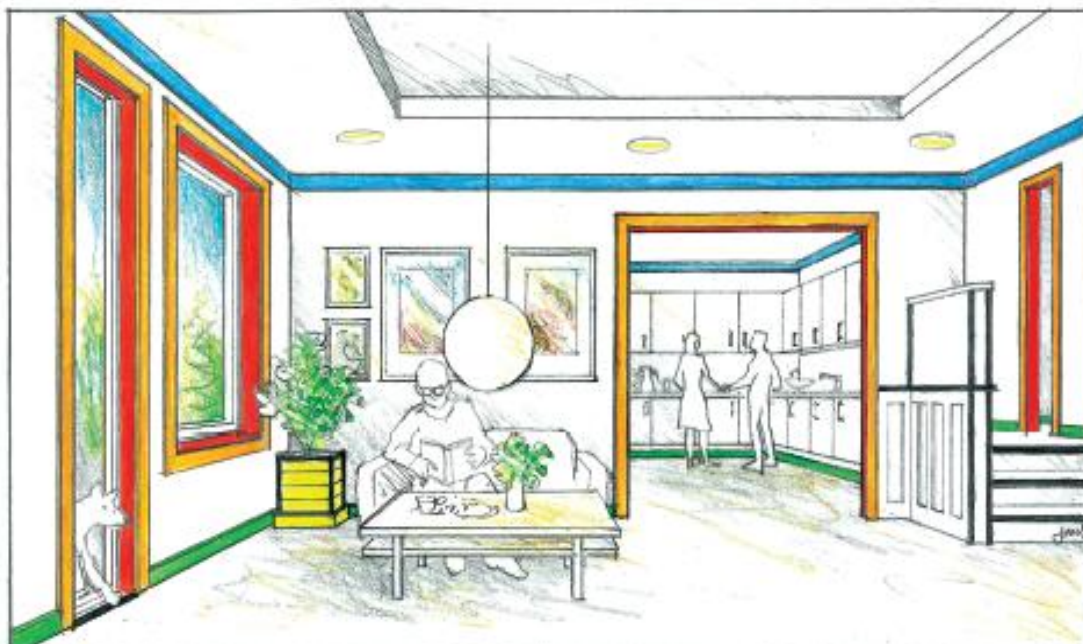

HITTA RÄTT LIST

Följ färgkodningen för att hitta den list ni söker

FODER

Foder används runt fönster och dörrar för att täcka skarven mellan karm och vägg.

SOCKEL

Sockel används för att täcka språngor mellan golv och vägg.

TAKLIST

Taklist används i övergången mellan tak och vägg för att täcka språngor.

ÖVRIGA LISTER

Övriga lister används primärt för att täcka språngor och skarvar, till exempel Foglist, Smygläst, Kvarstäv, Rundstäv mm.

FÖNSTERMYG/DÖRRUMFATTNING

Fönstersmyg används vid montering av fönster och dörrar som utsalning mot vägg. Dörrumfattning används där det saknas karm i dörrhål och väv.

PLANHYVLAT

Planhyvlat har många användningsområden. Planhyvlat används ofta vid utsalning av fönster och dörrar och till allmänna snickerier.



Innehåll













Foder slät	1
Klackfoder	2
Foder, profilerade	3
Socket	4
Socket, profilerade	5
Taklister	6
Bröstlister	7
Hörnlistor	8
Flexilist MDF	8
Salningslister	8
Smyglister	9
Falsad fönstersmyg Furu	10
Spårad fönstersmyg MDF	10
Falsad fönstersmyg MDF	11
Dörromfattning MDF	11
Dörromfattning Furu	12
Fogllister/Täckbräda	12
Rundstav	13
Halvstav	14
Kvartstav	14
Trekantslist	14
Kakellist	15
U-list	15
Dekorlist	15
Glaslist	15
Klossar	16
Kortlister	16
Planhyvlat	17
Lister MDF	19
Clips/Bättringsfärg	20
Bastuartiklar	20
Ribbpanel	20
Lustejp	20
Samtliga lister i kritvit	21
Samtliga lister i grundmålat	24
SimSalaBimlisten	24
Monteringsanvisning	25



	Foder slät	Dimension mm	Beskrivning	Enhet/bunt	Enhet
	200144	10x43x4400	Foder vit		10 st
	200344	10x56x4400	Foder vit		10 st
	200311	10x56x1100	Foder vit		5 st
	300344	10x56x4400	Foder kritvit		10 st
	200444	10x69x4400	Foder vit		10 st
	200644	12x43x4400	Foder vit		10 st
	2006	12x43x2200	Foder vit		10 st
	300544	12x43x4400	Foder kritvit		10 st
	300622	12x43x2200	Foder kritvit		10 st
	5005	12x43	Foder obh		28 lpm
	5006	12x43x2200	Foder obh		10 st
	900644	12x43x4400	Foder grundmålad		10 st
	4005	12x44	Foder Ek lackad		35 lpm
	201044	12x56x4400	Foder vit		10 st
	2010	12x56x2200	Foder vit		10 st
	201027	12x56x2700	Foder vit		10 st
	201030	12x56x3000	Foder Vit		10 st
	201036	12x56x3600	Foder vit		10 st
	3010300	12x56x3600	Foder kritvit		10 st
	301044	12x56x4400	Foder kritvit		10 st
	301022	12x56x2200	Foder kritvit		10 st
	301027	12x56x2700	Foder kritvit		10 st
	861022	12x56x2200	Foder svart		10 st
	841022	12x56x2200	Foder grå S 4500-N		10 st
	861030	12x56x3000	Foder svart		10 st
	5008	12x56	Foder obh		28 lpm
	5010	12x56x2200	Foder obh		10 st
	501033	12x56x3300	Foder obh		10 st
	901044	12x56x4400	Foder grundmålad		10 st
	9010	12x56x2200	Foder grundmålad		10 st
	6008	12x56	Foder Ek lasyr		28 lpm
	4008	12x56	Foder Ek lackad		35 lpm
	4010	12x56x2200	Foder Ek lackad		10 st
	401011	12x56x1100	Foder Ek lackad		5 st
	7508	12x58x4000	Foder Ekfanerad lackad		10 st
	7510	12x58x2200	Foder Ekfanerad lackad		10 st
	4930	12x56	Foder Björk lackad		35 lpm
	493022	12x56x2200	Foder Björk lackad		10 st
	4950	12x56	Foder Bok lackad		35 lpm
	495022	12x56x2200	Foder Bok lackad		10 st
	2009	12x56x2200+1100	Foderset vit		1 st
	3009	12x56x2200+1100	Foderset kritvit		1 st
	5009	12x56x2200+1100	Foderset obh		1 st
	201444	12x69x4400	Foder vit		10 st
	2014	12x69x2200	Foder vit		10 st
301944	12x69x4400	Foder kritvit		10 st	
301422	12x69x2200	Foder kritvit		10 st	
5013	12x69	Foder obh		28 lpm	











Foder slät, forts.		Dimension mm	Beskrivning	Enhet/bunt	Enhet
	5014	12x69x2200	Foder obh		10 st
	501433	12x69x3300	Foder obh		10 st
	901444	12x69x4400	Foder grundmålad		10 st
	4013	12x69	Foder Ek lackad		28 lpm
	2012	12x69x2200+1100	Foderset vit		1 st
	201644	12x95x4400	Foder vit		10 st
	301544	12x95x4400	Foder kritvit		10 st
	2016	12x95x2200	Foder vit		10 st
	301622	12x95x2200	Foder kritvit		10 lpm
	5015	12x95	Foder obh		28 lpm
	5016	12x95x2200	Foder obh		10 st
	901744	15x33x4400	Foder grundmålad		10 st
	201744	15x56x4400	Foder vit		10 st
	2018	15x56x2200	Foder vit		10 st
	9018	15x56x2200	Foder grundmålad		10 st
	302044	15x56x4400	Foder kritvit		8 st
	302022	15x56x2200	Foder kritvit		10 st
	202044	15x69x4400	Foder vit		8 st
	2021	15x69x2200	Foder vit		10 st
	501822	15x56x2200	Foder Furu obh		8 st







Klackfoder		Dimension mm	Beskrivning	Enhet/bunt	Enhet
	204044	15x56x4400	Klackfoder vit		10 st
	204144	21x43x4400	Klackfoder vit		10 st
	5041	21x43	Klackfoder obh		28 lpm
	204244	21x56x4400	Klackfoder vit		10 st
	5042	21x56	Klackfoder obh		28 lpm
	2043	21x56x2200	Klackfoder vit		8 st
	304244	21x56x4400	Klackfoder kritvit		10 st
	5043	21x56x2200	Klackfoder obh		10 st
	3043	21x56x2200	Klackfoder kritvit		8 st







Profilerade foder		Dimension mm	Beskrivning	Enhet/bunt	Enhet
	5020	15x56	Foder Furu obh/Skrea		28 lpm
	202444	15x69x4400	Allmogefoder vit (286)		8 st
	302444	15x69x4400	Allmogefoder kritvit (286)		8 st
	5023	15x69	Allmogefoder obh (286)		18 lpm
	5323	15x69	Allmogefoder obh B (286)		18 lpm
	2024	15x69x2200	Allmogefoder vit (286)		10 st
	3024	15x69x2200	Allmogefoder kritvit (286)		10 st
	5024	15x69x2200	Allmogefoder obh (286)		10 st
	202644	15x95x4400	Allmogefoder vit (287)		8 st
	302644	15x95x4400	Allmogefoder kritvit (287)		8 st
	5025	15x95	Allmogefoder obh (287)		18 lpm





Profilerade foder	Dimension mm	Beskrivning	Enhet/bunt	Enhet
	2026 15x95x2200	Allmogefoder vit (287)		5 st
	5026 15x95x2200	Allmogefoder obh (287)		5 st
	5028 15x95	Allmogefoder obh B (287)		18 lpm
	5029 21x120	Allmogefoder obh (287)		18 lpm
	203144 15x69x4400	Allmogefoder vit (289)		5 st
	5031 15x69	Allmogefoder obh (289)		18 lpm
	903844 21x95x4400	Allmogefoder grundmålad 343		5 st
	202744 15x69x4400	Allmogefoder vit (290)		5 st
	5027 15x69	Allmogefoder obh (290)		18 lpm
	203344 15x69x4400	Allmogefoder vit (291)		8 st
	5033 15x69	Allmogefoder obh (291)		18 lpm
	203444 15x95x4400	Allmogefoder vit (296)		5 st
	5034 15x95	Allmogefoder obh (296)		18 lpm
	202944 21x69x4400	Allmogefoder vit (298)		8 st
	203044 21x95x4400	Allmogefoder vit (307)		5 st
	5030 21x95	Allmogefoder obh (307)		15 lpm
	203544 15x69x4400	Allmogefoder vit (295)		8 st
	5035 15x69	Allmogefoder obh (295)		18 lpm
	203644 15x95x4400	Allmogefoder vit (239)		5 st
	5036 15x95	Allmogefoder obh (239)		18 lpm
	206044 21x95x4400	Allmogefoder West vit		5 st
	5060 21x95	Allmogefoder West obh		18 lpm
	5061 21x120	Allmogefoder West obh		18 lpm
	5160 21x95	Allmogefoder West gran		18 lpm
	5161 21x120	Allmogefoder West gran		18 lpm
	206244 15x69x4400	Allmogefoder Syd vit		8 st
	206222 15x69x2200	Allmogefoder Syd vit		10 st
	5062 15x69	Allmogefoder Syd obh		18 lpm
	506222 15x69x2200	Allmogefoder Syd obh		10 st
	206344 15x95x4400	Allmogefoder Syd vit		8 st
	206322 15x95x2200	Allmogefoder Syd vit		10 st
	5063 15x95	Allmogefoder Syd obh		18 lpm
	506322 15x95x2200	Allmogefoder Syd obh		10 st
	5038 21x95	Allmogefoder obh 343		18 lpm

	Socket	Dimension mm	Beskrivning	Enhet/bunt	Enhet
	220244	12x43x4400	Socket vit	10 st	
	320244	12x43x4400	Socket kritvit	10 st	
	5202	12x43	Socket obh	28 lpm	
	920244	12x43x4400	Socket grundmålad	10 st	
	4202	12x44	Socket Ek lackad	35 lpm	
	220444	12x56x4400	Socket vit	10 st	
	220424	12x56x2400	Socket vit	10 st	
	2204300	12x56x3000	Socket vit	10 st	
	2204360	12x56x3600	Socket vit	10 st	
	320344	12x56x4400	Socket kritvit	10 st	
	320324	12x56x2400	Socket kritvit	10 st	
	320330	12x56x3000	Socket kritvit	10 st	
	860436	12x56x3600	Socket svart	10 st	
	840436	12x56x3600	Socket grå S 4500-N	10 st	
	5204	12x56	Socket obh	28 lpm	
	520433	12x56x3300	Socket obh	10 st	
	920444	12x56x4400	Socket grundmålad	10 st	
	6204	12x56	Socket Eklasyr	28 lpm	
	4204	12x56	Socket Ek lackad	35 lpm	
	7704	12x58x4000	Socket Ekfanerad lackad	10 st	
	7709	12x58x4000	Socket Ekfanerad vit	10 st	
	4931	12x56	Socket Björk lackad	35 lpm	
	4951	12x56	Socket Bok lackad	35 lpm	
220544	12x69x4400	Socket vit	10 st		
220536	12x69x3600	Socket vit	10 st		
320744	12x69x4400	Socket kritvit	10 st		
860536	12x69x3600	Socket svart	10 st		
5205	12x69	Socket obh	28 lpm		
920544	12x69x4400	Socket grundmålad	10 st		
6205	12x69	Socket Eklasyr	28 lpm		
4205	12x69	Socket Ek lackad	35 lpm		
7705	12x70x4000	Socket Ekfanerad lackad	10 st		
220644	12x95x4400	Socket vit	10 st		
320644	12x95x4400	Socket kritvit	10 st		
5206	12x95	Socket obh	18 lpm		
220844	15x56x4400	Socket furu vit	8 st		
320944	15x56x4400	Socket furu kritvit	8 st		
220944	15x69x4400	Socket furu vit	8 st		
	230744	14x56x4400	Ventilerad sockel vit	8 st	
	5307	14x56	Ventilerad sockel obh	25 lpm	
	930844	14x69x4400	Ventilerad sockel grundm.	8 st	
	221044	15x56x4400	Socket kabelsp. Vit	8 st	
	7708	16x60x4000	Socket kabelsp. Ekfanér lack	10 st	

Profilerad sockel	Dimension mm	Beskrivning	Enhet/bunt	Enhet
	5209 15x69	Socket furu obh Skrea	28 lpm	
	5210 15x95	Socket furu obh Skrea	28 lpm	
	221144 15x69x4400	Allmogesocket vit (308)	8 st	
	221136 15x69x3600	Allmogesocket vit (308)	8 st	
	321144 15x69x4400	Allmogesocket kritvit (308)	8 st	
	5211 15x69	Allmogesocket obh (308)	18 lpm	
	5311 15x69	Allmogesocket obh B (308)	18 lpm	
	221244 15x95x4400	Allmogesocket vit (310)	8 st	
	321244 15x95x4400	Allmogesocket kritvit (310)	8 st	
	5212 15x95	Allmogesocket obh (310)	18 lpm	
	5213 15x95	Allmogesocket obh B (310)	18 lpm	
	221544 21x120x4400	Allmogesocket vit (312)	5 st	
	5215 21x120	Allmogesocket obh B (312)	18 lpm	
	223144 15x69x4400	Allmogesocket vit (330)	8 st	
	5231 15x69	Allmogesocket obh (330)	18 lpm	
	5232 15x95	Allmogesocket obh (331)	18 lpm	
	223544 15x69x4400	Allmogesocket vit (338)	8 st	
	5235 15x69	Allmogesocket obh (338)	18 lpm	
	223644 15x95x4400	Allmogesocket vit (339)	5 st	
	5236 15x95	Allmogesocket obh (339)	18 lpm	
	223344 15x69x4400	Allmogesocket vit (337)	5 st	
	5233 15x69	Allmogesocket obh (337)	18 lpm	
	223444 15x95x4400	Allmogesocket vit (332)	8 st	
	5234 15x95	Allmogesocket obh (332)	18 lpm	
	923844 21x95x4400	Allmogesocket Grundm (343)	5 st	
	5216 21x120	Allmogesocket obh B (343)	18 lpm	
	5218 21x120	Allmogesocket obh (343)	18 lpm	
	921844 21x120x4400	Allmogesocket Grundm.(343)	5 st	
	5217 21x145	Allmogesocket obh B (346)	18 lpm	
	5260 21x95	Allmogesocket West obh	18 lpm	
	226036 21x95x3600	Allmogesocket West vit	5 st	
	226144 21x120x4400	Allmogesocket West vit	5 st	
	5261 21x120	Allmogesocket West obh	18 lpm	
	226244 15x69x4400	Allmogesocket Syd vit	8 st	
	5262 15x69	Allmogesocket Syd obh	18 lpm	
	226344 15x95x4400	Allmogesocket Syd vit	8 st	
	5263 15x95	Allmogesocket Syd obh	18 lpm	

	Taklist	Dimension mm	Beskrivning	Enhet/bunt	Enhet
	5621	12x27	Hålkäl obh		36 lpm
	262144	12x27x4400	Hålkäl vit		10 st
	261044	15x33x4400	Hålkäl vit		10 st
	361036	15x33x3600	Hålkäl kritvit		10 st
	5610	15x33	Hålkäl obh		35 lpm
	261136	15x43x3600	Hålkäl vit		10 st
	261144	15x43x4400	Hålkäl vit		10 st
	361136	15x43x3600	Hålkäl kritvit		10 st
	361144	15x43x4400	Hålkäl kritvit		10 st
	5611	15x43	Hålkäl obh		35 lpm
	961144	15x43x4400	Hålkäl grundmålad		10 st
	261236	15x56x3600	Hålkäl vit		10 st
	261244	15x56x4400	Hålkäl vit		10 st
	361236	15x56x3600	Hålkäl kritvit		10 st
361244	15x56x4400	Hålkäl kritvit		10 st	
5612	15x56	Hålkäl obh		35 lpm	
961244	15x56x4400	Hålkäl grundmålad		10 st	
261344	20x69x4400	Hålkäl vit		10 st	
361336	20x69x3600	Hålkäl kritvit		10 st	
5613	20x69	Hålkäl obh		35 lpm	
5615	21x95	Hålkäl obh		18 lpm	
	261444	15x43x4400	Brättest vit 135°		10 st
	361436	15x43x3600	Brättest kritvit 135°		10 st
	5622	15x43	Taklist furu obh 45°		8 st
	263144	21x33x4400	Enkelskugga vit		10 st
	263136	21x33x3600	Enkelskugga vit		10 st
	363036	21x33x3600	Enkelskugga kritvit		10 st
	363044	21x33x4400	Enkelskugga kritvit		10 st
	963044	21x33x4400	Enkelskugga Grundmålad		10 st
	5631	21x33	Enkelskugga obh		35 lpm
	263244	21x43x4400	Dubbelskugga vit		10 st
	263236	21x43x3600	Dubbelskugga vit		10 st
	363444	21x43x4400	Dubbelskugga kritvit		10 st
	363436	21x43x3600	Dubbelskugga kritvit		10 st
	5632	21x43	Dubbelskugga obh		35 lpm
	263344	33x43x4400	Skugglist vit		10 st
	363336	33x43x3600	Skugglist kritvit		10 st
	5633	33x43	Skugglist obh		35 lpm
	5305	21x43	Trapplist obeh 354		20 lpm

Taklist forts	Dimension mm	Beskrivning	Enhet/bunt	Enhet
	260244 15x43x4400	Taklist vit Svanhals 361	10 st	
	360236 15x43x3600	Taklist kritvit Svanhals 361	10 st	
	5602 15x43	Taklist obh Svanhals 361	35 lpm	
	260344 15x56x4400	Taklist vit Svanhals 361	10 st	
	260336 15x56x3600	Taklist vit Svanhals 361	10 st	
	360336 15x56x3600	Taklist kritvit Svanhals 361	10 st	
	5603 15x56	Taklist obh Svanhals 361	35 lpm	
	960344 15x56x4400	Taklist grund Svanhals 361	10 st	
	260444 15x69x4400	Taklist vit Svanhals 361	5 st	
	360436 15x69x4400	Taklist kritvit Svanhals	10 st	
5604 15x69	Taklist obh Svanhals 361	18 lpm		
	260544 21x69x4400	Allmogetaklist vit 362	5 st	
	360536 21x69x3600	Taklist kritvit Allmoge 362	10 st	
	5605 21x69	Allmogetaklist obh 362	18 lpm	
	260944 15x43x440	Brättlist allmoge vit 411	10 st	
	360936 15x43x3600	Brättlist allmoge kritvit 411	10 st	
 	230444 15x69x4400	Allmogetaklist vit 363	8 st	
	5304 15x69	Allmogetaklist obh 363	18 lpm	
	330436 15x69x3600	Allmogetaklist kritvit 363	8 st	
	5303 15x69	Allmogetaklist obh B 363	18 lpm	
	5606 21x95	Allmogetaklist obh 381	18 lpm	
	260844 15x69x4400	Hålkäl allmoge vit 369	5 st	
	360836 15x69x3600	Hålkäl allmoge kritvit 369	8 st	
5608 15x69	Hålkäl allmoge obh 369	18 lpm		

Bröstlist	Dimension mm	Beskrivning	Enhet/bunt	Enhet
	250544 21x45x4400	Bröstlist vit fals 12 mm	10 st	
	5505 21x45	Bröstlist obh fals 12 mm	35 lpm	
	2506 21x43x2400	Bröstlist vit 390 m fals 6mm	10 st	
	5506 21x43	Bröstlist obh 390	35 lpm	
	5507 33x43	Bröstlist obh 392	35 lpm	
	5508 21x33	Bröstlist obh 395 fals 12mm	35 lpm	
	251036 27x43x3600	Bröstlist vit	6 st	

	Hörnlist	Dimension mm	Beskrivning	Enhet/bunt	Enhet
	343127	21x21x2700	Hörnlist kritvit	10 st	
	2431	21x21x2700	Hörnlist vit	10 st	
	5431	21x21x2700	Hörnlist obh	10 st	
	443127	21x21x2700	Hörnlist Ek lackad	10 st	
	2433	27x27x2700	Hörnlist vit	10 st	
	5433	27x27x2700	Hörnlist obh	10 st	
	443327	27x27x2700	Hörnlist Ek lackad	10 st	
	2435	33x33x2700	Hörnlist vit	10 st	
	343527	33x33x2700	Hörnlist kritvit	10 st	
	5435	33x33x2700	Hörnlist obh	10 st	
	2437	43x43x2700	Hörnlist vit	10 st	
	5437	43x43x2700	Hörnlist obh	10 st	
	5438	43x43x2700	Hörnlist obh fingerskarvad	10 st	

	Flexilist MDF	Dimension mm	Beskrivning	Enhet/bunt	Enhet
	1662	35x35x2700	Flexilist vit MDF - folierad	10 st	
	1665	28x28x2700	Flexilist vit MDF - folierad	10 st	
	166500	28x28x2700	Flexilist kritvit MDF -folierad	10 st	

	Salningslist	Dimension mm	Beskrivning	Enhet/bunt	Enhet
	242022	19x27x2200	Salningslist vit	10 st	
	342022	19x27x2200	Salningslist kritvit	10 st	
	242030	19x27x3000	Salningslist vit	10 st	
	242044	19x27x4400	Salningslist vit	10 st	
	342044	19x27x4400	Salningslist kritvit	10 st	
	240844	21x33x4400	Salningslist vit	6 st	
	342122	21x33x2200	Salningslist kritvit	6 st	
	2421	21x43x2200	Salningslist vit	6 st	
	242244	21x43x4400	Salningslist vit	6 st	
	342244	21x43x4400	Salningslist kritvit	6 st	
	2423	21x69x2200	Salningslist vit	6 st	
	242444	21x69x4400	Salningslist vit	6 st	
	342422	21x69x2200	Salningslist kritvit	6 st	
	342444	21x69x4400	Salningslist kritvit	6 st	
	242544	21x95x4400	Salningslist vit	6 st	
	342544	21x95x4400	Salningslist kritvit	6 st	
2426	21x95x2200	Salningslist vit	6 st		

Smyglist	Dimension mm	Beskrivning	Enhet/bunt	Enhet
	241044 8x15x4400	Smyglist vit	15 St	
	341044 8x15x4400	Smyglist kritvit	15 st	
	5410 8x15	Smyglist obh	54 lpm	
	241024 8x15x2400	Smyglist vit	15 st	
	541024 8x15x2400	Smyglist obh	15 st	
	4410 8x15	Smyglist Ek lackad	50 lpm	
	441024 8x15x2400	Smyglist Ek lackad	20 st	
	441012 8x15x1200	Smyglist Ek lackad	35 st	
	441010 8x15x1000	Smyglist Ek lackad	20 st	
	241144 8x21x4400	Smyglist vit	15 st	
	341144 8x21x4400	Smyglist kritvit	15 st	
	5411 8x21	Smyglist obh	54 lpm	
	241124 8x21x2400	Smyglist vit	15 st	
	541124 8x21x2400	Smyglist obh	15 st	
	4411 8x21	Smyglist Ek lackad	50 lpm	
	441110 8x21x1000	Smyglist Ek lackad	20 st	
	441124 8x21x2400	Smyglist Ek lackad	20 st	
	4936 8x21	Smyglist Björk lackad	50 lpm	
	241244 8x27x4400	Smyglist vit	15 st	
	341244 8x27x4400	Smyglist kritvit	15 st	
	5412 8x27	Smyglist obh	54 lpm	
	241224 8x27x2400	Smyglist vit	15 st	
	541224 8x27x2400	Smyglist obh	15 st	
	4412 8x27	Smyglist Ek lackad	50 lpm	
	441212 8x27x1200	Smyglist Ek lackad	35 st	
	441224 8x27x2400	Smyglist Ek lackad	20 st	
	241344 8x33x4400	Smyglist vit	15 st	
	341344 8x33x4400	Smyglist kritvit	15 st	
	5413 8x33	Smyglist obh	54 lpm	
	241324 8x33x2400	Smyglist vit	15 st	
	541324 8x33x2400	Smyglist obh	15 st	
	4413 8x33	Smyglist Ek lackad	50 lpm	
	441324 8x33x2400	Smyglist Ek lackad	20 st	
	241444 8x43x4400	Smyglist vit	15 st	
	341444 8x43x4400	Smyglist kritvit	15 st	
	5414 8x43	Smyglist obh	54 lpm	
	241424 8x43x2400	Smyglist vit	15 st	
	541424 8x43x2400	Smyglist obh	15 st	
	4414 8x44	Smyglist Ek lackad	50 lpm	
	441424 8x44x2400	Smyglist Ek lackad	20 st	
	2415 13x21x2200	Smyglist vit, rak bakkant	20 st	
	3415 13x21x2200	Smyglist kritvit, rak bak	20 st	
	241744 15x21x4400	Smyglist vit	10 st	
	241844 15x27x4400	Smyglist vit	10 st	
	241644 15x33x4400	Smyglist vit	10 st	
	5416 15x33	Smyglist obh	35 lpm	
	941644 15x33x4400	Smyglist grundmålad	10 st	

Falsad smyg, Furu	Dimension mm	Beskrivning	Enhet/bunt	Enhet
	2107	18x70x4400	Furusmyg fals vit -9,5x35	1 st
	2108	18x95x2400	Furusmyg fals vit -9,5x35	1 st
	2109	18x95x4400	Furusmyg fals vit -9,5x35	1 st
	2110	18x120x2400	Furusmyg fals vit -9,5x35	1 st
	2111	18x120x4400	Furusmyg fals vit -9,5x35	1 st
	3111	18x120x4400	Furusmyg fals -9,5x35 kritvit	1 st
	2112	18x145x2400	Furusmyg fals vit -9,5x35	1 st
	2113	18x145x4400	Furusmyg fals vit -9,5x35	1 st
	3113	18x145x4400	Furusmyg fals -9,5x35 kritvit	1 st
	2114	18x170x2400	Furusmyg fals vit -9,5x35	1 st
	2115	18x170x4400	Furusmyg fals vit -9,5x35	1 st
	3115	18x170x4400	Furusmyg fals -9,5x35 kritvit	1 st
	2116	18x195x2400	Furusmyg fals vit -9,5x35	1 st
	2117	18x195x4400	Furusmyg fals vit -9,5x35	1 st
	3117	18x195x4400	Furusmyg fals -9,5x35 kritvit	1 st
	2118	18x220x2400	Furusmyg fals vit -9,5x35	1 st
	2120	18x250x2400	Furusmyg fals vit -9,5x60	1 st
	2121	18x250x4400	Furusmyg fals vit -9,5x60	1 st
	3121	18x250x4400	Furusmyg fals -9,5x60 kritvit	1 st
	2123	18x300x4400	Furusmyg fals vit -9,5x60	1 st
	2124	18x350x2400	Furusmyg fals vit -9,5x60	1 st
	2125	18x350x4400	Furusmyg fals vit -9,5x60	1 st

Spårad smyg, MDF	Dimension mm	Beskrivning	Enhet/bunt	Enhet
	1101	16x75x2440	Smyg, spårad MDF	3 st
	1102	16x75x4200	Smyg, spårad MDF	3 st
	110200	16x75x4200	Smyg, spårad MDF kritvit	3 st
	1103	16x100x2440	Smyg, spårad MDF	3 st
	1104	16x100x4200	Smyg, spårad MDF	3 st
	110400	16x100x4200	Smyg, spårad MDF kritvit	3 st
	1105	16x125x2440	Smyg, spårad MDF	3 st
	1106	16x125x4200	Smyg, spårad MDF	3 st
	110600	16x125x4200	Smyg, spårad MDF kritvit	3 st
	1107	16x150x2440	Smyg, spårad MDF	2 st
	1108	16x150x4200	Smyg, spårad MDF	2 st
	110800	16x150x4200	Smyg, spårad MDF kritvit	3 st
	1109	16x175x2440	Smyg, spårad MDF	2 st
	1110	16x175x4200	Smyg, spårad MDF	2 st
	111000	16x175x4200	Smyg, spårad MDF kritvit	3 st
	1111	16x200x2440	Smyg, spårad MDF	2 st
	1112	16x200x4200	Smyg, spårad MDF	2 st
	111200	16x200x4200	Smyg, spårad MDF kritvit	2 st
	1113	16x250x2440	Smyg, spårad MDF	2 st
	1114	16x250x4200	Smyg, spårad MDF	2 st
111400	16x250x4200	Smyg, spårad MDF kritvit	2 st	
1115	16x300x2440	Smyg, spårad MDF	2 st	
1116	16x300x4200	Smyg, spårad MDF	2 st	

Falsad smyg, MDF		Dimension mm	Beskrivning	Enhet/bunt	Enhet
	1118	16x50x4200	Smyg, falsad MDF - 9,5x25		5 st
	1119	16x60x4200	Smyg, falsad MDF - 9,5x25		5 st
	1120	16x75x2440	Smyg, falsad MDF - 9,5x25		3 st
	1121	16x75x4200	Smyg, falsad MDF - 9,5x25		3 st
	112100	16x75x4200	Smyg, falsad MDF kritvit		3 st
	1122	16x100x2440	Smyg, falsad MDF - 9,5x35		3 st
	1123	16x100x4200	Smyg, falsad MDF - 9,5x35		3 st
	112300	16x100x4200	Smyg, falsad MDF kritvit		3 st
	1124	16x125x2440	Smyg, falsad MDF - 9,5x35		3 st
	1125	16x125x4200	Smyg, falsad MDF - 9,5x35		3 st
	112500	16x125x4200	Smyg, falsad MDF kritvit		3 st
	1126	16x150x2440	Smyg, falsad MDF - 9,5x35		2 st
	1127	16x150x4200	Smyg, falsad MDF - 9,5x35		2 st
	112700	16x150x4200	Smyg, falsad MDF kritvit		2 st
	1128	16x175x2440	Smyg, falsad MDF - 9,5x35		2 st
	1129	16x175x4200	Smyg, falsad MDF - 9,5x35		2 st
	112900	16x175x4200	Smyg, falsad MDF kritvit		2 st
	1130	16x200x2440	Smyg, falsad MDF - 9,5x35		2 st
	1131	16x200x4200	Smyg, falsad MDF - 9,5x35		2 st
	113100	16x200x4200	Smyg, falsad MDF kritvit		2 st
1132	16x250x2440	Smyg, falsad MDF - 9,5x60		2 st	
1133	16x250x4200	Smyg, falsad MDF - 9,5x60		2 st	
1136	16x350x2400	Smyg, falsad MDF - 9,5x60		2 st	

Dörrömfattning, MDF		Dimension mm	Beskrivning	Enhet/bunt	Enhet
	1001	16x80x2440	Omfattning, 4 rk MDF		3 st
	100100	16x80x2440	Omfattning, 4 rk MDF kritvit		3 st
	1002	16x80x4200	Omfattning, 4 rk MDF		3 st
	1003	16x95x2440	Omfattning, 4 rk MDF		3 st
	100300	16x95x2440	Omfattning, 4 rk MDF kritvit		3 st
	1004	16x95x4200	Omfattning, 4 rk MDF		3 st
	1005	16x105x2440	Omfattning, 4 rk MDF		3 st
	100500	16x105x2440	Omfattning, 4 rk MDF kritvit		3 st
	1006	16x105x4200	Omfattning, 4 rk MDF		3 st
	1007	16x120x2440	Omfattning, 4 rk MDF		3 st
	100700	16x120x2440	Omfattning, 4 rk MDF kritvit		3 st
	1008	16x120x4200	Omfattning, 4 rk MDF		3 st
	1009	16x130x2440	Omfattning, 4 rk MDF		3 st
	100900	16x130x2440	Omfattning, 4 rk MDF kritvit		3 st
	1010	16x130x4200	Omfattning, 4 rk MDF		3 st
	1011	16x145x2440	Omfattning, 4 rk MDF		3 st
	101100	16x145x2440	Omfattning, 4 rk MDF kritvit		3 st
1012	16x145x4200	Omfattning, 4 rk MDF		3 st	
1013	16x155x2440	Omfattning, 4 rk MDF		2 st	
101300	16x155x2440	Omfattning, 4 rk MDF kritvit		2 st	
1014	16x155x4200	Omfattning, 4 rk MDF		2 st	
1015	16x170x2440	Omfattning, 4 rk MDF		2 st	
1016	16x170x4200	Omfattning, 4 rk MDF		2 st	

Dörromfattning, MDF	Dimension mm	Beskrivning	Enhet/bunt	Enhet
	1017 16x200x2440	Omfattning, 4 rk MDF		2 st
	101700 16x200x2440	Omfattning, 4 rk MDF kritvit		2 st
	1018 16x200x4200	Omfattning, 4 rk MDF		2 st

Dörromfattning, Furu	Dimension mm	Beskrivning	Enhet/bunt	Enhet
	2150 16x80x2400	Dörromfattning Furu vit		1 st
	3150 16x80x2400	Dörromfattning Furu kritvit		1 st
	2151 16x95x2400	Dörromfattning Furu vit		1 st
	3151 16x95x2400	Dörromfattning Furu kritvit		1 st
	2152 16x105x2400	Dörromfattning Furu vit		1 st
	3152 16x105x2400	Dörromfattning Furu kritvit		1 st
	2153 16x120x2400	Dörromfattning Furu vit		1 st
	3153 16x120x2400	Dörromfattning Furu kritvit		1 st
	2154 16x130x2400	Dörromfattning Furu vit		1 st
	3154 16x130x2400	Dörromfattning Furu kritvit		1 st
	2155 16x145x2400	Dörromfattning Furu vit		1 st
	3155 16x145x2400	Dörromfattning Furu kritvit		1 st
	2156 16x155x2400	Dörromfattning Furu vit		1 st
	3156 16x155x2400	Dörromfattning Furu kritvit		1 st
	2157 16x170x2400	Dörromfattning Furu vit		1 st
	3157 16x170x2400	Dörromfattning Furu kritvit		1 st
	2158 16x200x2400	Dörromfattning Furu vit		1 st
	3158 16x200x2400	Dörromfattning Furu kritvit		1 st

Foglist/Täckbräda	Dimension mm	Beskrivning	Enhet/bunt	Enhet
	5400 6x21	Foglist obh		66 lpm
	240024 8x15x2400	Foglist vit		15 st
	540024 8x15x2400	Foglist obh		15 st
	440024 8x15x2400	Foglist Ek lackad		20 st
	240144 8x21x4400	Foglist vit		15 st
	5401 8x21	Foglist obh		54 lpm
	240124 8x21x2400	Foglist vit		15 st
	340144 8x21x4400	Foglist kritvit		15 st
	540124 8x21x2400	Foglist obh		15 st
	4401 8x21	Foglist Ek lackad		50 lpm
	440110 8x21x1000	Foglist Ek lackad		20 st
	440124 8x21x2400	Foglist Ek lackad		20 st
	240244 8x27x4400	Foglist vit		15 st
	340244 8x27x4400	Foglist kritvit		15 st
	5402 8x27	Foglist obh		54 lpm
	240224 8x27x2400	Foglist vit		15 st
	540224 8x27x2400	Foglist obh		15 st
	4402 8x27	Foglist Ek lackad		50 lpm
	440210 8x27x1000	Foglist Ek lackad		20 st
	440224 8x27x2400	Foglist Ek lackad		20 st
	240344 8x33x4400	Foglist vit		15 st
	340344 8x33x4400	Foglist kritvit		15 st
	340325 8x33x2500	Foglist kritvit		15 st

Foglist/Täckbräda	Dimension mm	Beskrivning	Enhet/bunt	Enhet
5403	8x33	Foglist obh	54 lpm	
240324	8x33x2400	Foglist vit	15 st	
540324	8x33x2400	Foglist obh	15 st	
4403	8x33	Foglist Ek lackad	50 lpm	
440324	8x33x2400	Foglist Ek lackad	20 st	
240444	8x43x4400	Foglist vit	15 st	
340444	8x43x4400	Foglist kritvit	15 st	
5404	8x43	Foglist obh	54 lpm	
240424	8x43x2400	Foglist vit	15 st	
540424	8x43x2400	Foglist obh	15 st	
4404	8x44	Foglist Ek lackad	50 lpm	
440424	8x44x2400	Foglist Ek lackad	20 st	
4405	8x95	Foglist Ek lackad	30 lpm	
242944	21x69x4400	Täckbräda vit	6 st	
242922	21x69x2200	Täckbräda vit	6 st	
342922	21x69x2200	Täckbräda kritvit	6 st	
342944	21x69x4400	Täckbräda kritvit	6 st	
2430440	21x95x4400	Täckbräda vit	6 st	
2430	21x95x2200	Täckbräda vit	6 st	
343022	21x95x2200	Täckbräda kritvit	6 st	
343044	21x95x4400	Täckbräda kritvit	6 st	
242744	21x120x4400	Täckbräda vit	3 st	
242722	21x120x2200	Täckbräda vit	6 st	
342744	21x120x4400	Täckbräda kritvit	3 st	
242844	21x145x4400	Täckbräda vit	3 st	
242822	21x145x2200	Täckbräda vit	6 st	
342822	21x145x2200	Täckbräda kritvit	6 st	

Rundstav	Dimension mm	Beskrivning	Enhet/bunt	Enhet
5461	8	Rundstav obeh	72 lpm	
546125	8x2500	Rundstav obeh	20 st	
5462	10	Rundstav obeh	72 lpm	
546225	10x2500	Rundstav obeh	20 st	
5463	12	Rundstav obeh	72 lpm	
546325	12x2500	Rundstav obeh	20 st	
5464	15	Rundstav obeh	72 lpm	
546425	15x2500	Rundstav obeh	20 st	
5465	21	Rundstav obeh	54 lpm	
546525	21x2500	Rundstav obeh	20 st	
5466	25	Rundstav obeh	54 lpm	
546625	25x2500	Rundstav obeh	15 st	
5467	27	Rundstav obeh	54 lpm	
546725	27x2500	Rundstav obeh	15 st	
5468	33	Rundstav obeh	35 lpm	
546825	33x2500	Rundstav obeh	10 st	
5469	43	Rundstav obeh	35 lpm	
546925	43x2500	Rundstav obeh	10 st	
4469	43	Rundstav ek (beställningsvara)		

	Halvstav Dimension mm	Beskrivning	Enhet/bunt	Enhet
--	------------------------------	-------------	------------	-------



547825 33x2500 Halvstav obeh 10 st

	Kvartstav Dimension mm	Beskrivning	Enhet/bunt	Enhet
--	-------------------------------	-------------	------------	-------



244124 9x9x2400 Kvartstav vit 20 st
544124 9x9x2400 Kvartstav obh 20 st
4441 9x9 Kvartstav Ek lackad 50 lpm
444124 9x9x2400 Kvartstav Ek lackad 20 st
244244 12x12x4400 Kvartstav vit 20 st
344244 12x12x4400 Kvartstav kritvit 20 st
5442 12x12 Kvartstav obeh 70 lpm
244224 12x12x2400 Kvartstav vit 20 st
544224 12x12x2400 Kvartstav obh 20 st
6442 12x12 Kvartstav Ek lasyr 70 lpm
4442 12x12 Kvartstav Ek lackad 50 lpm
444210 12x12x1000 Kvartstav Ek lackad 20 st
444212 12x12x1200 Kvartstav Ek lackad 20 st
444215 12x12x1500 Kvartstav Ek lackad 20 st
444224 12x12x2400 Kvartstav Ek lackad 20 st
244344 15x15x4400 Kvartstav vit 20 st
5443 15x15 Kvartstav obeh 70 lpm
244324 15x15x2400 Kvartstav vit 20 st
344324 15x15x2400 Kvartstav kritvit 20 st
544324 15x15x2400 Kvartstav obh 20 st
4443 15x15 Kvartstav Ek lackad 50 lpm
444310 15x15x1000 Kvartstav Ek lackad 20 ST
444312 15x15x1200 Kvartstav Ek lackad 20 st





	Kvartstav forts. Dimension mm	Beskrivning	Enhet/bunt	Enhet
--	--------------------------------------	-------------	------------	-------

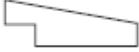

444324 15x15x2400 Kvartstav Ek lackad 20 st
244444 21x21x4400 Kvartstav vit 20 st
5444 21x21 Kvartstav obeh 54 lpm
244424 21x21x2400 Kvartstav vit 20 st
544424 21x21x2400 Kvartstav obh 20 st
4444 21x21 Kvartstav Ek lackad 50 lpm
444424 21x21x2400 Kvartstav Ek lackad 20 st
544524 27x27x2400 Kvartstav obeh 20 st

	Trekantslist Dimension mm	Beskrivning	Enhet/bunt	Enhet
--	----------------------------------	-------------	------------	-------

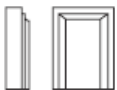
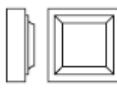
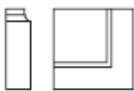

5449 15 Trekant Furu A 150 lpm
5450 21 Trekant Furu A 150 lpm
5451 27 Trekant Furu A 150 lpm
5456 21 Trekant Gran 60 lpm

Tavelhängarlist		Dimension mm	Beskrivning	Enhet/bunt	Enhet
	261536	15x43x3600	Furu vit		12 st
Kakellist		Dimension mm	Beskrivning	Enhet/bunt	Enhet
	246044	15x57x4400	Kakellist vit		10 st
U-list		Dimension mm	Beskrivning	Enhet/bunt	Enhet
	247044	21x27x4400	U-list Furu vit		10 st
	347044	21x27x4400	U-list Furu kritvit		10 st
	247144	15x31x4400	U-list Furu vit		10 st
	347144	15x31x4400	U-list Furu kritvit		10 st
Dekorlist		Dimension mm	Beskrivning	Enhet/bunt	Enhet
	570124	8,5x22x2400	Dekorlist furu obeh		10 st
	570224	12x34x2400	Dekorlist furu obeh		10 st
	570324	9x21x2400	Dekorlist furu obeh		20 st
	570424	12x33x2400	Dekorlist furu obeh		20 st
	570524	15x45x2400	Dekorlist furu obeh		10 st
Glaslist		Dimension mm	Beskrivning	Enhet/bunt	Enhet
	248044	11x23x4400	Glaslist Furu vit 424		10 st
	5481	15x21	Glaslist Obh		36 lpm

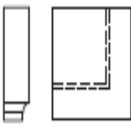
Klossar		Dimension mm	Beskrivning	Enhet/bunt	Enhet
	27510028	75x100x28	Bottenkloss vit	2 frp	
	57510028	75x100x28	Bottenkloss obh	2 frp	
	210015528	100x155x28	Bottenkloss vit	2 frp	
	510015528	100x155x28	Bottenkloss obh	2 frp	
	310015528	100x155x28	Bottenkloss kritvit	2 frp	
	2757528	75x75x28	Toppkloss vit	2 frp	
	5757528	75x75x28	Toppkloss obh	2 frp	
	210010028	100x100x28	Toppkloss vit	2 frp	
	510010028	100x100x28	Toppkloss obh	2 frp	
	23030100	30x30x100	Socketkloss innehörn vit	2 frp	
	53030100	30x30x100	Socketkloss innehörn obh	2 frp	
	23030155	30x30x155	Socketkloss innehörn vit	2 frp	
	53030155	30x30x155	Socketkloss innehörn obh	2 frp	
	24040155	40x40x155	Socketkloss ytterhörn vit	2 frp	
	54040155	40x40x155	Socketkloss ytterhörn obh	2 frp	
	52076300	20x76x300	Socketkloss Skrea obh	2 frp	
	520102300	20x102x300	Socketkloss Skrea obh	2 frp	
	525125300	25x125x300	Socketkloss Skrea obh	2 frp	
	2353570	35x35x70	Takkloss innehörn vit	2 frp	
	3353570	35x35x70	Takkloss innehörn kritvit	2 frp	
	5353570	35x35x70	Takkloss innehörn obh	2 frp	
	2505090	50x50x90	Takkloss innehörn vit	2 frp	
	3505090	50x50x90	Takkloss innehörn kritvit	2 frp	
	5505090	50x50x90	Takkloss innehörn obh	2 frp	

Kortlister		Dimension mm	Beskrivning	Enhet/bunt	Enhet
	8576894	12x43x1000	Foder Furu vit	10 st	
	8576895	12x56x1000	Foder Furu vit	10 st	
	8576896	12x69x1000	Foder Furu vit	10 st	
	8738669	8x1000	Rundstav obeh	20 st	
	8576933	10x1000	Rundstav obeh	20 st	
	8738668	15x1000	Rundstav obeh	20 st	
	8576934	21x1000	Rundstav obeh	20 st	
	8576955	25x1000	Rundstav obeh	20 st	
	8576935	27x1000	Rundstav obeh	20 st	
	8576936	33x1000	Rundstav obeh	20 st	
	8580112	21x21x1000	Hörnlist obeh	10 st	
	8580113	27x27x1000	Hörnlist obeh	10 st	
	8576974	21x21x1000	Hörnlist vit	10 st	
	8576975	27x27x1000	Hörnlist vit	10 st	

Kortlister, Forts.	Dimension mm	Beskrivning	Enhet/bunt	Enhet
8576937	12x12x1000	Kvartstav obeh	20 st	
8576938	15x15x1000	Kvartstav obeh	20 st	
8576939	21x21x1000	Kvartstav obeh	20 st	
8576948	12x12x1000	Kvartstav vit	20 st	
8576949	15x15x1000	Kvartstav vit	20 st	
8738664	21x21x1000	Kvartstav vit	20 st	
444212	12x12x1200	Kvartstav Ek lackad	20 st	
8576940	8x21x1000	Foglist obeh	15 st	
440110	8x21x1000	Foglist Ek lackad	20 st	
8576941	8x27x1000	Foglist obeh	15 st	
8576942	8x33x1000	Foglist obeh	15 st	
8576953	8x43x1000	Foglist obeh	15 st	
8738661	8x21x1000	Foglist vit	15 st	
8738662	8x27x1000	Foglist vit	15 st	
8576956	8x33x1000	Foglist vit	15 st	
8738663	8x43x1000	Foglist vit	15 st	
8576943	8x15x1000	Smyglist Obeh	15 st	
441010	8x15x1000	Smyglist Ek lackad	20 st	
8576944	8x21x1000	Smyglist Obeh	15 st	
441110	8x21x1000	Smyglist Ek lackad	20 st	
8576945	8x27x1000	Smyglist Obeh	15 st	
8576957	8x15x1000	Smyglist vit	15 st	
8576958	8x21x1000	Smyglist vit	15 st	
8738670	8x27x1000	Smyglist vit	15 st	
441012	8x15x1200	Smyglist Ek lackad	20 st	
441212	8x27x1200	Smyglist Ek lackad	20 st	
8576959	8x15x1000	Planhyvlad furu	10 st	
8738667	8x43x1000	Planhyvlad furu	10 st	
8576969	8x69x1000	Planhyvlad furu	10 st	
8576965	8x95x1000	Planhyvlad furu	10 st	
8738665	12x12x1000	Planhyvlad furu	10 st	
8576968	12x33x1000	Planhyvlad furu	10 st	
8576970	15x15x1000	Planhyvlad furu	10 st	
8576960	15x27x1000	Planhyvlad furu	5 st	
8738666	15x33x1000	Planhyvlad furu	6 st	
8576961	15x43x1000	Planhyvlad furu	5 st	
8576962	21x21x1000	Planhyvlad furu	6 st	
8576963	21x33x1000	Planhyvlad furu	4 st	
8576964	21x43x1000	Planhyvlad furu	4 st	
8576971	21x69x1000	Planhyvlad furu	4 st	
8576972	21x95x1000	Planhyvlad furu	4 st	



Planhyvlat	Dimension mm	Beskrivning	Enhet/bunt	Enhet
5801	8x21	Planhyvlat furu	36 lpm	
5800	8x27	Planhyvlat furu	36 lpm	
5802	8x33	Planhyvlat furu	36 lpm	
5803	8x43	Planhyvlat furu	36 lpm	
5804	8x69	Planhyvlat furu	36 lpm	
4804	8x70	Planhyvlat Ek	35 lpm	
480412	8x70x1200	Planhyvlat Ek	10 st	
5805	8x95	Planhyvlat furu	36 lpm	
4805	8x95	Planhyvlat Ek	35 lpm	
480512	8x95x1200	Planhyvlat Ek	10 st	
4806	8x120	Planhyvlat Ek	35 lpm	
4807	8x145	Planhyvlat Ek	10 lpm	
5807	12x21	Planhyvlat furu	36 lpm	
5838	12x33	Planhyvlat furu	18 lpm	
5839	12x44	Planhyvlat furu	35 lpm	
5808	15x15	Planhyvlat furu	36 lpm	
5809	15x21	Planhyvlat furu	22 lpm	
281044	15x27x4400	Planhyvlat furu vit	10 st	
5810	15x27	Planhyvlat furu	22 lpm	
581033	15x27x3300	Planhyvlat furu	6 st	
5811	15x33	Planhyvlat furu	22 lpm	
581124	15x33x2400	Planhyvlat furu	6 st	
581133	15x33x3300	Planhyvlat furu	6 st	
5812	15x43	Planhyvlat furu	18 lpm	
4812	15x44	Planhyvlat Ek	50 lpm	
281344	15x69x4400	Planhyvlat furu vit	10 st	
5813	15x69	Planhyvlat furu	18 lpm	
581324	15x69x2400	Planhyvlat furu	5 st	
581333	15x69x3300	Planhyvlat furu	5 st	
4813	15x70	Planhyvlat Ek	25 lpm	
481312	15x70x1200	Planhyvlat Ek	6 st	
5814	15x95	Planhyvlat furu	18 lpm	
581424	15x95x2400	Planhyvlat furu	5 st	
581433	15x95x3300	Planhyvlat furu	5 st	
4814	15x95	Planhyvlat Ek	25 lpm	
481412	15x95x1200	Planhyvlat Ek	6 st	
5815	15x118	Planhyvlat furu	18 lpm	
4815	15x120	Planhyvlat Ek	25 lpm	
5816	15x143	Planhyvlat furu	14 lpm	
4816	15x145	Planhyvlat Ek	25 lpm	
5817	21x21	Planhyvlat furu	22 lpm	
4817	21x21	Planhyvlat Ek	35 lpm	
5818	21x27	Planhyvlat furu	22 lpm	
5819	21x33	Planhyvlat furu	14 lpm	

Planhyvlat, forts.		Dimension mm	Beskrivning	Enhet/bunt	Enhet
	581933	21x33x3300	Planhyvlat furu		4 st
	4819	21x33	Planhyvlat Ek		35 lpm
	282044	21x43x4400	Planhyvlat furu vit		10 st
	5820	21x43	Planhyvlat furu		14 lpm
	582033	21x43x3300	Planhyvlat furu		4 st
	4820	21x44	Planhyvlat Ek		25 lpm
	5836	21x56	Planhyvlat furu		14 lpm
	5821	21x69	Planhyvlat furu		14 lpm
	582133	21x69x3300	Planhyvlat furu		4 st
	4821	21x70	Planhyvlat Ek		15 lpm
	482112	21x70x1200	Planhyvlat Ek		4 st
	5822	21x95	Planhyvlat furu		14 lpm
	582233	21x95x3300	Planhyvlat furu		4 st
	4822	21x95	Planhyvlat Ek		15 lpm
	482212	21x95x1200	Planhyvlat Ek		4 st
	5823	21x118	Planhyvlat furu		14 lpm
	582333	21x118x3300	Planhyvlat furu		4 st
	4823	21x120	Planhyvlat Ek		10 lpm
	5824	21x143	Planhyvlat furu		14 lpm
	582433	21x143x3300	Planhyvlat furu		4 st
	4824	21x145	Planhyvlat Ek		10 lpm
	5825	21x165	Planhyvlat furu		14 lpm
	5841	21x185	Planhyvlat furu		14 lpm
	4826	21x200	Planhyvlat Ek		10 lpm
	5827	27x27	Planhyvlat furu		14 lpm
	5828	27x69	Planhyvlat furu		14 lpm
	5840	27x95	Planhyvlat furu		15 lpm
	4829	27x95	Planhyvlat Ek		15 lpm
	5829	27x118	Planhyvlat furu		14 lpm
	5830	33x33	Planhyvlat furu		11 lpm
	5837	33x43	Planhyvlat furu		11 lpm
	5831	33x69	Planhyvlat furu		11 lpm
	5832	33x95	Planhyvlat furu		11 lpm
	5833	33x118	Planhyvlat furu		11 lpm
	5834	33x143	Planhyvlat furu		11 lpm
	5835	44x44	Planhyvlat furu		11 lpm

Lister i MDF		Dimension mm	Beskrivning	Enhet/bunt	Enhet
	1301	12x43x2200	Foder vit MDF		10 st
	1302	12x43x4200	Foder vit MDF		10 st
	1303	12x56x2200	Foder vit MDF		10 st
	1304	12x56x4200	Foder vit MDF		10 st
	1305	12x69x2200	Foder vit MDF		10 st

Lister i MDF forts.		Dimension mm	Beskrivning	Enhet/bunt	Enhet
		1306 12x69x4200	Foder vit MDF	10 st	
		1307 12x95x2440	Foder vit MDF	10 st	
		1308 12x95x4200	Foder vit MDF	10 st	
		1407 16x95x2440	Allmogefoder vit MDF	5 st	
		1408 16x95x4200	Allmogefoder vit MDF	5 st	
		1352 12x56x4200	Sockel vit MDF	10 st	
		1454 16x95x4200	Allmogesockel vit MDF	5 st	

Clips/Bättringsfärg		Dimension mm	Beskrivning	Enhet/bunt	Enhet
		8010	Dorn för metallclips	1 st	
		8011	Metallclips	400st/frp	Frp
		8013	Metallclips	50st/frp	Frp
		8015	Metallclips Skruv 1,25x40mm	250st/frp	Frp
		8020	Bättringsfärg S 0502-Y	1 st	
		8025	Bättringsfärg S 0500-N	1 st	
		8026	Bättringsfärg svart S 9000-N	1 st	
		8027	Bättringsfärg grå S 4500-N	1 st	









Bastuartiklar		Dimension mm	Beskrivning	Enhet/bunt	Enhet
		7914 12x65	Bastupanel Asp	10st/bunt	lpm
		7920 21x65	Bastulav Asp	10st/bunt	lpm
		790524 12x42x2400	Bastufoder Asp	10 st	









Ribbpanel		Dimension mm	Beskrivning	Enhet/bunt	Enhet
		60041845 21x300x2400	Ribbpanel Castle Oak	2 st/förp.	förp.
		60041808 21x300x2400	Ribbpanel Pepper Oak	2 st/förp.	förp.
		60056880 20x71x2770	Avslutningsprofil Castle Oak	2 st/förp.	förp.
		60056883 20x71x2770	Avslutningsprofil Pepper Oak	2 st/förp.	förp.
		61095240 10x95x2400	Sockel Ribbpanel Svart	5st/förp	st







Lustejp		Dimension mm	Beskrivning	Enhet/bunt	Enhet
		8050	Lustejp 20 mm, 100m/rulle	100m	Rulle
		8055 12x56x3000	Sockel med lustejp Furu kritvit	10 st	
		8056 12x56x3000	Sockel med lustejp Furu vit	10 st	



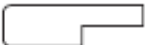



Kilar		Dimension mm	Beskrivning	Enhet/bunt	Enhet
		51068235 14x48x130	Träkil (minsta best.vol 28 frp)	12 frp	
		60693502 14x48x130	Spånkil (minsta best.vol 28 frp)	12 frp	

Övrigt		Dimension mm	Beskrivning	Enhet/bunt	Enhet
		9001	Broschyr, sortimentslista	1 st	
		8016	Listjiggen plast svart	1 st	

Samtliga lister i kritvit	Dimension mm	Beskrivning	Enhet/bunt	Enhet
	300344	10x56x4400	Foder kritvit	10 st
	300544	12x43x4400	Foder kritvit	10 st
	300622	12x43x2200	Foder kritvit	10 st
	301044	12x56x4400	Foder kritvit	10 st
	3010300	12x56x3000	Foder kritvit	10 st
	301022	12x56x2200	Foder kritvit	10 st
	301027	12x56x2700	Foder kritvit	10 st
	3009	12x56x2200+1100	Foderset kritvit	1 set
	301944	12x69x4400	Foder kritvit	10 st
	301422	12x69x2200	Foder kritvit	10 st
	301544	12x95x4400	Foder kritvit	10 st
	301622	12x95x2200	Foder kritvit	10 st
	302044	15x56x4400	Foder kritvit	8 st
	302022	15x56x2200	Foder kritvit	10 st
		304244	21x56x4400	Klackfoder kritvit
3043		21x56x2200	Klackfoder kritvit	8 st
	3024	15x69x2200	Allmogefoder kritvit (286)	10 st
	302444	15x69x4400	Allmogefoder kritvit (286)	8 st
	302644	15x95x4400	Allmogefoder kritvit (287)	8 st
	320244	12x43x4400	Sockel kritvit	10 st
	320324	12x56x2400	Sockel kritvit	10 st
	320330	12x56x3000	Sockel kritvit	10 st
	320344	12x56x4400	Sockel kritvit	10 st
	320744	12x69x4400	Sockel kritvit	10 st
	320644	12x95x4400	Sockel kritvit	10 st
	320944	15x56x4400	Sockel kritvit	8 st
	8055	12x56x3000	Sockel med lustejp Furu kritvit	10 st
		321144	15x69x4400	Allmogesockel kritvit (308)
321244		15x95x4400	Allmogesockel kritvit (310)	8 st
	361036	15x33x3600	Hålkäl kritvit	10 st
	361136	15x43x360	Hålkäl kritvit	10 st
	361144	15x43x4400	Hålkäl kritvit	10 st
	361236	15x56x3600	Hålkäl kritvit	10 st
	361244	15x56x4400	Hålkäl kritvit	10 st
	361336	20x69x3600	Hålkäl kritvit	10 st
	360236	15x43x3600	Taklist kritvit Svanhals 361	10 st
	360336	15x56x3600	Taklist kritvit Svanhals 361	10 st
	360436	15x69x3600	Taklist kritvit Svanhals 361	10 st
	363036	21x33x3600	Enkelskugga kritvit	10 st
	363044	21x33x4400	Enkelskugga kritvit	10 st
	363336	33x43x3600	Enkelskugga kritvit	10 st

Samtliga lister i kritvit	Dimension mm	Beskrivning	Enhet/bunt	Enhet
	363436 21x43x3600	Dubbelskugga kritvit	10 st	
	363444 21x43x4400	Dubbelskugga kritvit	10 st	
	360536 21x69x3600	Taklist kritvit Allmoge 362	10 st	
	330436 15x69x3600	Taklist kritvit Allmoge 363	8 st	
	360836 15x69x3600	Taklist kritvit Allmoge 369	8 st	
	360936 15x43x3600	Bråttlist kritvit Allmoge 411	10 st	
	361436 15x43x3600	Bråttlist kritvit 135°	10 st	
	343127 21x21x2700	Hörnlist kritvit	10 st	
	343527 33x33x2700	Hörnlist kritvit	10 st	
	166500 28x28x2700	Flexilist kritvit MDF -folierad	10 st	
	342022 19x27x2200	Salningslist kritvit	10 st	
	342044 19x27x4400	Salningslist kritvit	10 st	
	342122 21x33x2200	Salningslist kritvit	6 st	
	342244 21x43x4400	Salningslist kritvit	6 st	
	342422 21x69x2200	Salningslist kritvit	6 st	
	342444 21x69x4400	Salningslist kritvit	6 st	
	342544 21x95x4400	Salningslist kritvit	6 st	
	341044 8x15x4400	Smyglist furu kritvit	15 st	
	341144 8x21x4400	Smyglist kritvit	15 st	
	341244 8x27x4400	Smyglist kritvit	15 st	
	341344 8x33x4400	Smyglist kritvit	15 st	
	341444 8x43x4400	Smyglist kritvit	15 st	
	3415 13x21x2200	Smyglist kritvit	20 st	
	340144 8x21x4400	Foglist kritvit	15 st	
	340244 8x27x4400	Foglist kritvit	15 st	
	340325 8x33x2500	Foglist kritvit	15 st	
	340344 8x33x4400	Foglist kritvit	15 st	
	340444 8x43x4400	Foglist kritvit	15 st	
	342922 21x69x2200	Täckbräda kritvit	6 st	
	342944 21x69x4400	Täckbräda kritvit	6 st	
	343022 21x95x2200	Täckbräda kritvit	6 st	
	343044 21x95x4400	Täckbräda kritvit	6 st	
	342744 21x120x4400	Täckbräda kritvit	3 st	
	342822 21x145x2200	Täckbräda kritvit	6 st	
	344244 12x12x4400	Kvarstav kritvit	20 st	
	344324 15x15x2400	Kvarstav kritvit	20 st	

Samtliga lister i kritvit	Dimension mm	Beskrivning	Enhet/bunt	Enhet
	3111	18x120x4400	Furusmyg fals -9,5x35 kritvit	1 st
	3113	18x145x4400	Furusmyg fals -9,5x35 kritvit	1 st
	3115	18x170x4400	Furusmyg fals -9,5x35 kritvit	1 st
	3117	18x195x4400	Furusmyg fals -9,5x35 kritvit	1 st
	3121	18x250x4400	Furusmyg fals -9,5x35 kritvit	1 st
	110200	16x75x4200	Smyg, spårad MDF kritvit	3 st
	110400	16x100x4200	Smyg, spårad MDF kritvit	3 st
	110600	16x125x4200	Smyg, spårad MDF kritvit	3 st
	110800	16x150x4200	Smyg, spårad MDF kritvit	3 st
	111000	16x175x4200	Smyg, spårad MDF kritvit	3 st
	111200	16x200x4200	Smyg, spårad MDF kritvit	2 st
	111400	16x250x4200	Smyg, spårad MDF kritvit	2 st
	112100	16x75x4200	Fönstersmyg fals kritvit	3 st
	112300	16x100x4200	Fönstersmyg fals kritvit	3 st
	112500	16x125x4200	Fönstersmyg fals kritvit	3 st
	112700	16x150x4200	Fönstersmyg fals kritvit	2 st
	112900	16x175x4200	Fönstersmyg fals kritvit	2 st
	113100	16x200x4200	Fönstersmyg fals kritvit	2 st
	100100	16x80x2440	Dörromfattning MDF kritvit	3 st
	100300	16x95x2440	Dörromfattning MDF kritvit	3 st
	100500	16x105x2440	Dörromfattning MDF kritvit	3 st
	100700	16x120x2440	Dörromfattning MDF kritvit	3 st
	100900	16x130x2440	Dörromfattning MDF kritvit	3 st
	101100	16x145x2440	Dörromfattning MDF kritvit	3 st
	101300	16x155x2440	Dörromfattning MDF kritvit	2 st
	101700	16x200x2440	Dörromfattning MDF kritvit	2 st
	3150	16x80x2400	Dörromfattning Furu kritvit	1 st
	3151	16x95x2400	Dörromfattning Furu kritvit	1 st
	3152	16x105x2400	Dörromfattning Furu kritvit	1 st
	3153	16x120x2400	Dörromfattning Furu kritvit	1 st
	3154	16x130x2400	Dörromfattning Furu kritvit	1 st
	3155	16x145x2400	Dörromfattning Furu kritvit	1 st
	3156	16x155x2400	Dörromfattning Furu kritvit	1 st
	3157	16x170x2400	Dörromfattning Furu kritvit	1 st
	3158	16x200x2400	Dörromfattning Furu kritvit	
	3353570	35x35x70	Takkloss innerhörn kritvit	2 frp
	3505090	50x50x90	Takkloss innerhörn kritvit	2 frp
	310015528	100x155x28	Bottenkloss kritvit	2 frp
	347044	21x27x4400	U-list Furu kritvit	10 st
	347144	15x31x4400	U-list Furu kritvit	10 st

Lister i grundmål	Dimension mm	Beskrivning	Enhet/bunt	Enhet
	900644 12x43x4400	Foder grundmål	10 st	
	901044 12x56x4400	Foder grundmål	10 st	
	9010 12x56x2200	Foder grundmål	10 st	
	901444 12x69x4400	Foder grundmål	10 st	
	901744 15x33x4400	Foder grundmål	10 st	
	9018 15x56x2200	Foder grundmål	10 st	
	930844 14x69x4400	Ventilerad sockel grundm.	8 st	
	903844 21x95x4400	Allmogefoder grundmål 343	5 st	
	920244 12x43x4400	Sockel grundmål	10 st	
	920444 12x56x4400	Sockel grundmål	10 st	
	920544 12x69x4400	Sockel grundmål	10 st	
	923844 21x95x4400	Allmogesockel Grundm.(343)	5 st	
	921844 21x120x4400	Allmogesockel Grundm.(343)	5 st	
	961144 15x43x4400	Hålkäl grundmål	10 st	
	961244 15x56x4400	Hålkäl grundmål	10 st	
	960344 15x56x4400	Taklist grund Svanhals	10 st	
	963044 21x33x4400	Enkelskugga Grundmål	10 st	
	941644 15x33x4400	Smyglist grundmål	10 st	

Sim-SALA-bimlist	Dimension mm	Beskrivning	Enhet/bunt	Enhet
	8030 18,9x23,2x4200	SimSALAbimlist	8 st	
	8031 18,9x23,2x2500	SimSALAbimlist	8 st	
	8035 70x70	Montagehörn SimSALAbim	4 st	



På vår webb finns en länk till en film om hur SimSALAbim-listen monteras:
www.ehlprolist.se

Med metallclips

Art.nr: 8011, 400-pack

Art.nr: 8013, 50-pack

Art.nr Dorn: 8010

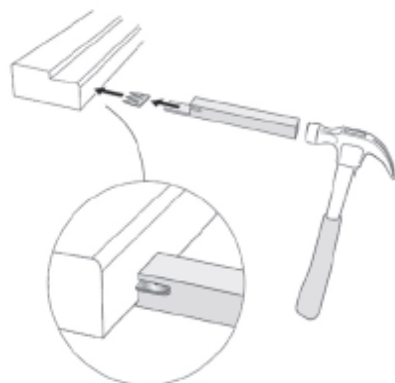

1. Montera clipsen med ca 250-300 mm mellanrum (Åtgång: 3-4 st/meter).

U-list furu vit

Art.nr: 247044

347044



2.

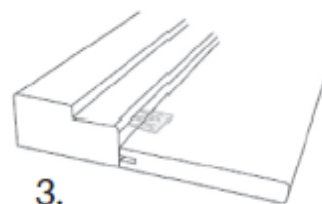

3.